

- TRINCIATRICI ARTIC PESANTE -

MODELLO SPOSTABILE PER VIGNETO E FRUTTETO:

Adatta per erba e potature fino a 6 centimetri di diametro. Per trattori da 35 CV a 60 CV. Applicabile posteriormente, realizzata con fiancata destra arrotondata. Predisposta per utilizzo con testate interfilari



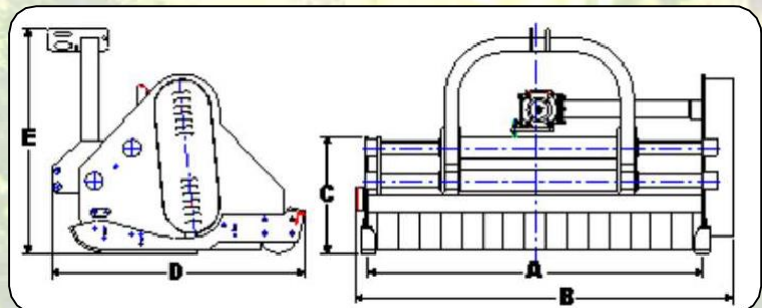

DOTAZIONE DI SERIE:

- Gruppo moltiplicatore a 540 g/min con ruota libera.
- Doppia scocca con griglia
- Attacco a 3 punti con spostamento idraulico di 350mm
- Rullo posteriore
- Slitte regolabili
- Palette anteriori in acciaio

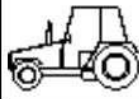

OPTIONAL:

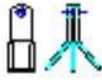
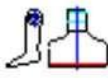
- Ruote anteriori in sostituzione alle slitte

Modello	A							B	C	D	E
	cm	CV	rev/min	Kg	N°	N°	N°	cm	cm	cm	cm
Artic P-140	140	35-60	540	410	32	16	3	149			
Artic P-150	150	40-60	540	420	36	18	3	163	/	/	/
Artic P-165	165	50-60	540	440	36	18	3	178			